

# MAGNEHELIC® DIFFERENTIAL PRESSURE GAGES

Indicate Positive, Negative or Differential, Accurate within 1%



Standard Magnehelic® gage



High Accuracy Magnehelic® gage  
Note: Shown with optional -SS bezel

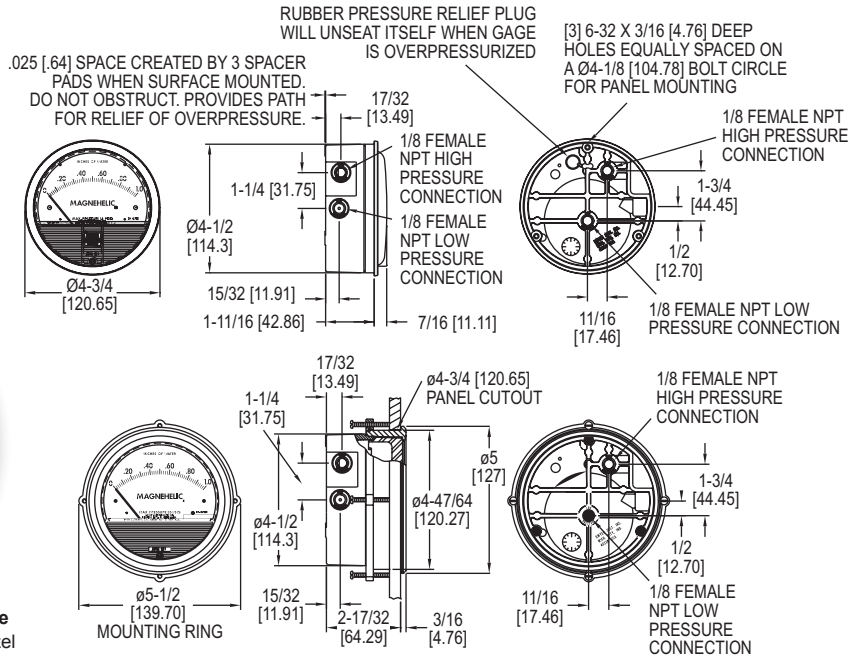

Select the **Series 2000 Magnehelic® Differential Pressure Gages** for a versatile low differential pressure gage with a wide choice of 81 models and 27 options to choose from. Using Dwyer's simple, frictionless Magnehelic® gage movement, it quickly indicates air or non-corrosive gas pressures—either positive, negative (vacuum) or differential. The design resists shock, vibration, over-pressures and is weatherproof to IP67.

Select the -HA High Accuracy Magnehelic® gage option for an accuracy within 1% of full-scale. Also included with the -HA option at no extra cost are a mirrored scale overlay and a 6 point calibration certificate.

**FEATURES/BENEFITS**

- Easy to read gage through undistorted plastic face permits viewing from far away
- Patented design provides quick response to pressure changes means no delay in assessing critical situations
- Durable and rugged housing and high-quality components combine to provide long-service life and minimized down-time
- High accuracy option is twice as accurate as the standard Magnehelic® gage

**APPLICATIONS**

- Filter monitoring
- Air velocity with Dwyer pitot tube
- Blower vacuum monitoring
- Fan pressure indication
- Duct, room or building pressures
- Clean room positive pressure indication

**ACCESSORIES**

Model	Description
A-432	Portable kit; combine carrying case with any Magnehelic® gage of standard range, except high pressure connection. Includes 9 ft (2.7 m) of 3/16" ID rubber tubing, standhang bracket and terminal tube with holder
A-605	Air filter gage accessory kit; adapts any standard Magnehelic® gage for use as an air filter gage. Includes aluminum surface mounting bracket with screws, two 5 ft (1.5 m) lengths of 1/4" aluminum tubing, two static pressure tips and two molded plastic vent valves, integral compression fittings on both tips and valves
A-605B	Air filter gage accessory kit; air filter kit with two plastic open/close valves, two 4" steel static tips, plastic tubing and mounting flange
A-605C	Air filter gage accessory kit; air filter kit with two plastic open/close valves, two plastic static tips, plastic tubing and mounting flange

**SPECIFICATIONS**

**Service:** Air and non-combustible, compatible gases (natural gas option available).  
**Note:** May be used with hydrogen. Order a Buna-N diaphragm. Pressures must be less than 35 psi.  
**Wetted Materials:** Consult factory.  
**Housing:** Die cast aluminum case and bezel, with acrylic cover. Exterior finish is coated gray to withstand 168 hour salt spray corrosion test.  
**Accuracy:** ±2% (-HA model ±1) of FS (±3% (-HA ±1.5%) on -0, -100PA, -125PA, -10MM and ±4% (-HA ±2%) on -00, -60PA, -6MM ranges), throughout range at 70°F (21.1°C).  
**Pressure Limits:** -20 in Hg to 15 psig (-0.677 to 1.034 bar); MP option: 35 psig (2.41 bar); HP option: 80 psig (5.52 bar).  
**Enclosure Rating:** IP67.  
**Overpressure:** Relief plug opens at approximately 25 psig (1.72 bar), standard gages only. ●  
**Temperature Limits:** 20 to 140°F\* (-6.67 to 60°C). -20°F (-28°C) with low temperature option.  
**Size:** 4" (101.6 mm) diameter dial face.  
**Mounting Orientation:** Diaphragm in vertical position. Consult factory for other position orientations.  
**Process Connections:** 1/8" female NPT duplicate high and low pressure taps - one pair side and one pair back.  
**Weight:** 1 lb 2 oz (510 g), MP & HP 2 lb 2 oz (963 g).  
**Standard Accessories:** Two 1/8" NPT plugs for duplicate pressure taps, two 1/8" pipe thread to rubber tubing adapter, and three flush mounting adapters with screws. (Mounting and snap ring retainer substituted for three adapters in MP & HP gage accessories.)  
**Agency Approvals:** Meets the technical requirements of EU Directive 2011/65/EU (RoHS II). **Note:** -SP models not RoHS approved.  
**Note:** For applications with high cycle rate within gage total pressure rating, next higher rating is recommended. See Medium and High pressure options.  
 \*Low temperature models available as special options.



A-432

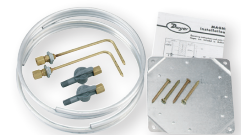

A-605

● Over Protection Note: See page 21 (Series 2000)





# HIGH ACCURACY MAGNEHELIC® DIFFERENTIAL PRESSURE GAGE

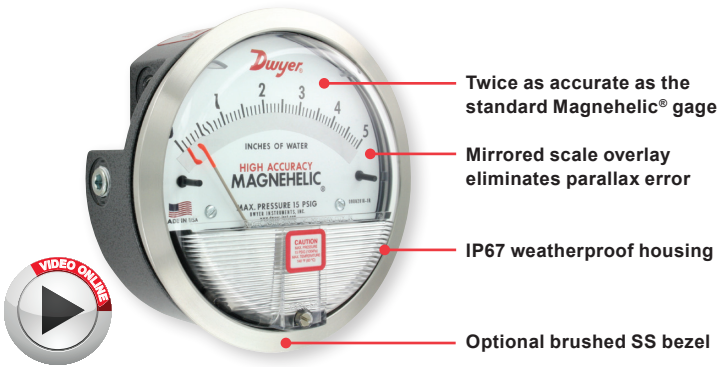

6-point calibration certificate included

OPTIONS - HIGH ACCURACY MAGNEHELIC® GAGE	
To order add suffix:	Description
-HA	High Accuracy Magnehelic® Gage. Accuracy within 1% and weatherproof. Also includes mirrored scale overlay and a six point calibration certificate
-SS	Corrosion resistant brushed 304 stainless steel bezel

Accuracy Specifications: See page 20 (Series 2000)

## ADDITIONAL GAGE OPTIONS

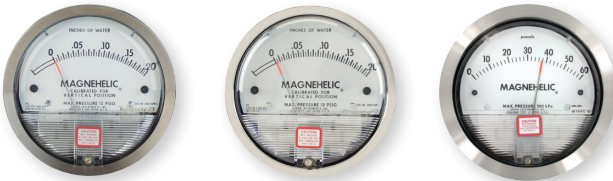

OPTIONS - OTHER OPTIONAL BEZELS	
To order add suffix:	Description
-CB	Chrome bezel option: A chrome plated aluminum bezel for an aesthetically pleasing finish when mounting on metal surfaces such as control panels.
-SB	Stainless steel bezel option: 304 stainless steel electro polished Ra 16 finished bezel.
-SS	Corrosion resistant brushed 304 stainless steel bezel



LED set point indicator

Adjustable signal flag

OPTIONS - LED SET POINT INDICATOR	
To order add suffix:	Description
-SP	Bright red LED on right scale shows when set point is reached. Field adjustable from gage face, unit operates on 12-24 VDC. Set point indicator option comes with medium pressure (MP) bezel.

Note: 4-13/16" hole for flush mounting.



Transparent overlay

Mirrored scale overlay

OPTIONS - ADJUSTABLE SIGNAL FLAG	
To order add suffix:	Description
-ASF	Integral with plastic gage cover. Available for most models except those with medium or high pressure construction. Can be ordered with gage or separate.

OPTIONS - TRANSPARENT OVERLAYS	
To order add suffix:	Description
-G	Green (to highlight and emphasize critical pressures)
-R	Red (to highlight and emphasize critical pressures)
-Y	Yellow (to highlight and emphasize critical pressures)

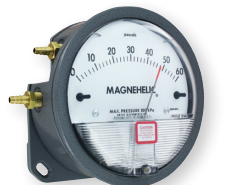

Integrated mounting plate

OPTIONS - MIRRORED SCALE OVERLAY	
To order add suffix:	Description
-M	A mirrored scale overlay is also available to assist in reducing parallax error.

OPTIONS - INTEGRATED MOUNTING PLATE	
To order add suffix:	Description
-AHU1	Furnished with attached surface mounting plate
-AHU2	Furnished with attached surface mounting plate and including A-481 installer kit (2 plastic static pressure tips and 7' of PVC tubing)



OPTIONS - FOR HIGH STATE PRESSURE APPLICATIONS	
To order add suffix:	Description
-HP	High pressure option: for pressures to 80 psig
-MP	Medium pressure option: for pressures to 35 psig

OPTIONS	
To order add suffix:	Description
-FC	Factory calibration certificate
-LT	Low temperatures to -20°F (-28°C)
-NIST	NIST traceable calibration certificate



# MAGNEHELIC® GAGE MOUNTING ACCESSORIES



A-610



A-369



Pressure reference port

A-464

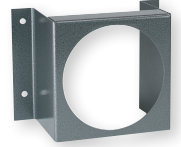

A-299



A-286



A-300



A-368

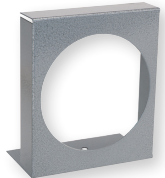
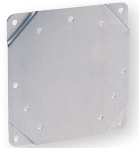

A-371

A single case size is used for most models of Magnehelic® gages. They can be flush or surface mounted with standard hardware supplied. Complete mounting and connection fittings plus instructions are furnished with each instrument. A 4-9/16" hole is required for flush panel mounting.

Flush mounting is easily accomplished with the new A-300 Flush Mounting bracket. This bracket provides a solution to quickly and conveniently flush mount the Magnehelic® gage. The A-300 is ideal for mounting the Magnehelic® gage on control panel doors.

The A-368 is a simple bracket for quickly surface mounting the Magnehelic® gage. After securing the Magnehelic® gage to the A-368 bracket, mount the bracket on any flat surface.

The A-369 allows the Magnehelic® gage to be easily carried to locations where pressure readings need to be taken. The A-369 can stand on its own or hang on a nail or hook.

ACCESSORIES	
Model	Description
A-610	Pipe mounting kit for installing on 1-1/4" to 2" horizontal or vertical pipe
A-286	Magnehelic® gage panel mounting flange
A-369	Stand-hang bracket, aluminum, for Magnehelic® gage
A-300	Flush mounting bracket
A-464	Flush mount kit for Magnehelic® gage
A-368	Surface mounting plate, aluminum, for Magnehelic® gage
A-299	Mounting bracket, flush mount for Magnehelic® gage, bracket is then surface mounted, steel with gray hammerloid epoxy finish
A-371	Surface mounting bracket, use with medium pressure (-MP) or high pressure (-HP) models only

## SERIES A-320

# INSTRUMENT ENCLOSURES

Protects Various Instruments



A-320-A



A-320-A with gage installed



A-320-B



A-320-B with gage installed

Series A-320 Instrument Enclosures protect instruments in all applications. The A-320-A fits standard Magnehelic® size instruments (4-9/16" diameter) and the A-320-B fits standard 3000MR Photohelic® switch/gage size instruments (4-13/16" diameter). Both models include silicone tubing, gage barbs and mounting hardware.

MODEL CHART	
Model	Compatible Instruments
A-320-A	2000 Magnehelic® gage, DM-1000 digital differential pressure gage, DM-2000 differential pressure transmitter
A-320-B	3000MR Photohelic® switch/gage, Series 605 Magnehelic® differential pressure transmitter, DH3 Dighelic® pressure controller, 2000 Magnehelic® gage with medium and high pressure options

SPECIFICATIONS	
<b>Housing:</b>	ABS.
<b>Process Connections:</b>	Anodized aluminum.
<b>Enclosure Rating:</b>	NEMA 1 (IP10). Note: Check instruments rating.
<b>Weight:</b>	Model A-320-A: 11.29 oz (320 g); A-320-B: 16.23 oz (420 g).
<b>Gage Size Opening:</b>	A-320-A: 4-9/16 in (115.89 mm); A-320-B: 4-13/16 in (122.24 mm).